



ANLY TEMPERATURE CONTROLLER

AT02 PID TEMPERATURE CONTROLLER



CHARACTERISTICS :

- Easy-to-use
- PID function selectable
- Relay or SSR output, selectable via DIP switch
- Accepts thermocouple and platinum RTD inputs
- Heating or cooling control selectable
- Panel lock protection function
- Sensor malfunction detection function
- Available in 5 sizes : 48 x 48mm(1/16DIN), 48 x 96mm(1/16DIN), 72 x 72, 96 x 48mm, 96 x 96mm(1/4DIN)

TYPE SELECTION :

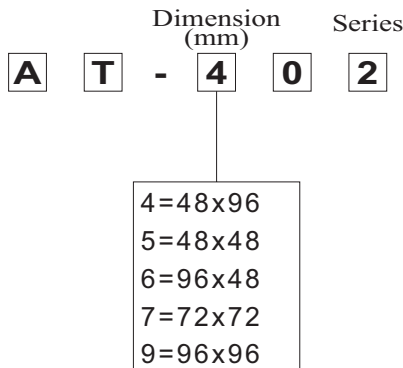





SPECIFICATIONS :

Type	AT-402 / AT-502 / AT-602 / AT-702 / AT902	
Operating voltage	AC/DC(V) : 24~48(for AT-502 only) / 100 ~ 240	
Rated frequency	50 / 60 Hz	
Power consumption	Approx. 3.5VA	
Sensor input (DIP SW. Setting)	Thermocouple	K, J, R
	RTD	Pt100
Control output (DIP SW. Setting)	Relay	240VAC 3A
	SSR	DC 24V
Alarm output	240VAC 3A	
Alarm function	See figure 1	
Control method	PID, PI, P, ON/OFF, Dead Band	
Setting	Digital setting using front panel keys	
Indicator	7-segment-display and LED	
Ambient temperature	-10 ~ +50°C	
Storage temperature	-25 ~ +65°C	
Ambient humidity	35 ~ 80%RH (with no icing or condensation)	
Storage humidity	35 ~ 95%RH (with no condensation)	
Weight	AT-402 / 602 Approx. 187g, AT-502 Approx. 145g, AT-702 Approx.200g , AT-902 Approx. 241g	

FEATURES :

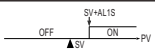
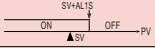
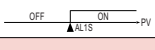
Type	AT-402 / AT-502 / AT-602 / AT-702 / AT902
Measuring accuracy	Within $\pm 0.3\%$ of present value or $\pm 2^\circ\text{C}$ whichever is greater
Proportional band (P)	0.0 ~ 300.0sec (0.1-second units)
Integral time (I)	0 ~ 7200sec (1-second units)
Derivative time (D)	0 ~ 1800sec (1-second units)
Control period	0 ~ 65sec (1-second units)
Sampling period	250ms
Memory protection	EEPROM non-volatile memory (writing times : Approx. 100,000times)

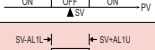
FIGURE 1 (ALARM FUNCTION) :

AF1	Alarm function selection
1	Deviation high alarm 
2	Deviation low alarm 
3	Process high alarm 
4	Process low alarm 
5	Deviation high/low alarm 
6	Band alarm 
7	Deviation high alarm (standby)
8	Deviation high alarm (standby)
9	Process high alarm (standby)
10	Process low alarm (standby)
11	Deviation high/low alarm (standby)
12	Band alarm (standby)

RATED SCALE :

Input type	°C	°F
K	0~1200	32~2192
J	0~500	32~932
R	0~1700	32~3092
PT-100	-50~400	-122~752

CONNECTION :

AT-402 / 602 / 902

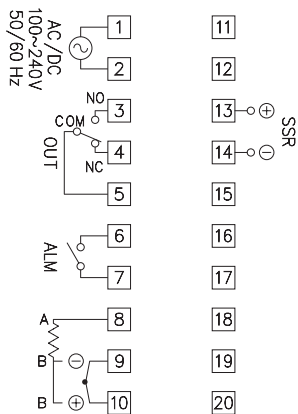

AT-502

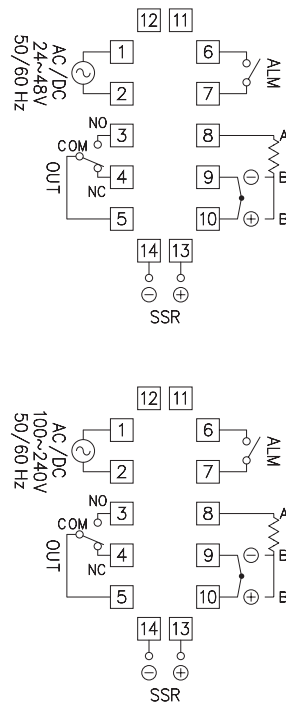

AT-702

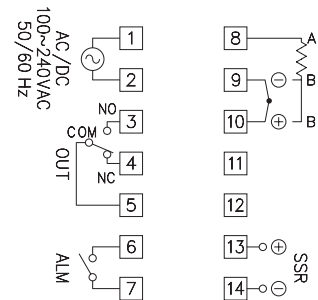

DIMENSIONS : (mm)

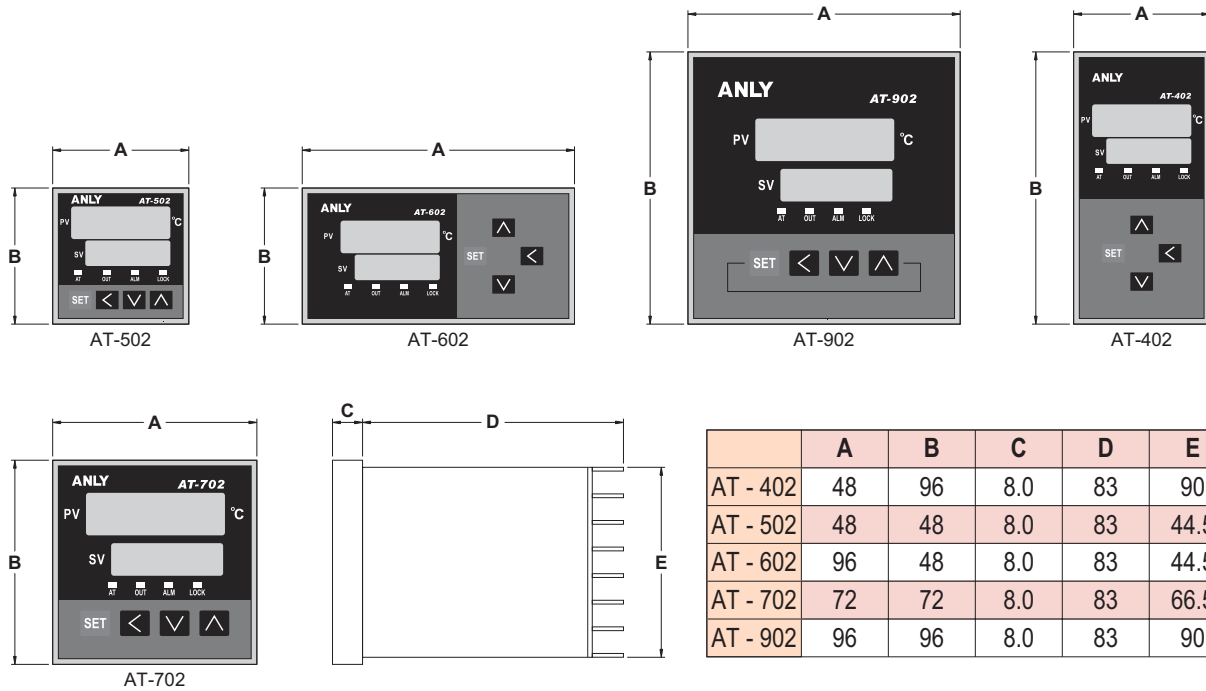

PANEL CUTOUT DRAWING : (mm)

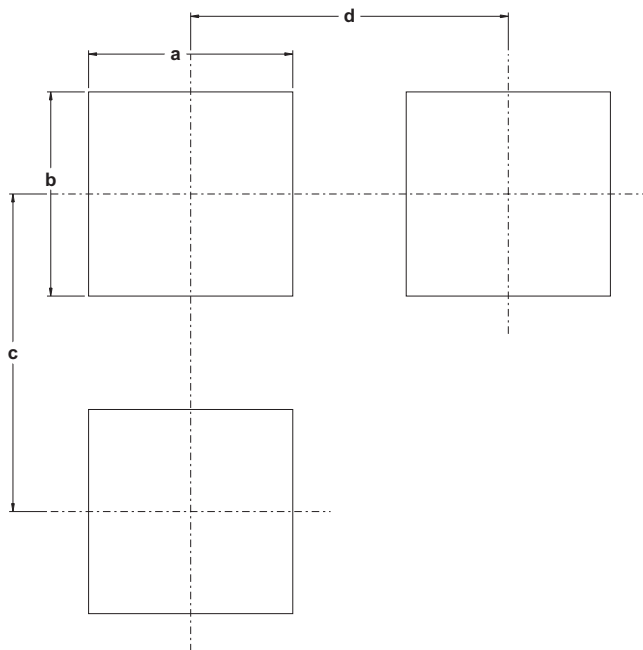

	a	b	c	d
AT - 402	45.5 ^{+0.5} ₋₀	91 ^{+0.5} ₋₀	120	70
AT - 502	45.5 ^{+0.5} ₋₀	45.5 ^{+0.5} ₋₀	70	70
AT - 602	91 ^{+0.5} ₋₀	45.5 ^{+0.5} ₋₀	70	120
AT - 702	67.5 ^{+0.5} ₋₀	67.5 ^{+0.5} ₋₀	100	100
AT - 902	91 ^{+0.5} ₋₀	91 ^{+0.5} ₋₀	120	120

ANLY ELECTRONICS CO., LTD.

<http://www.anly.com.tw>

TAIWAN MAIN OFFICE : ANLY ELECTRONICS CO., LTD.

No.19, Lane 202, Fushou St., Xinzhuang Dist., New Taipei City 242, Taiwan
 TEL: +886-2-2996-3202 FAX: +886-2-2996-2017

MALAYSIA BRANCH : JUSTY ELECTRONICS (M) SDN, BHD.

No.1, Jalan 6/89B, Kawasan Perindustrian Trisegi, Batu 3 1/2 Off Jalan Sungei Besi, 57100 Kuala Lumpur, Malaysia
 TEL: +60-3-7983-5758 FAX: +60-3-7981-5052

HONG KONG BRANCH : ANLY ELECTRONICS (HK) LTD.

Flat K, 13/F, Edward Mansion, 141 Prince Edward Road W., Kowloon, Hong Kong
 TEL: +852-2397-2505 FAX: +852-2397-6080

SHANGHAI BRANCH : ANLY TECHNOLOGY (WUXI) CO., LTD.

Room 13G, No.831, Xinzha Rd., Jingan District, Shanghai, China 200041
 TEL: +86-21-6218-3300 FAX: +86-21-6217-5911